

# Data Sheet



Article number: 5863502812

Description: Ball Valve 350.2812, G 1" - G 1"  
Thread/Thread

## Measures

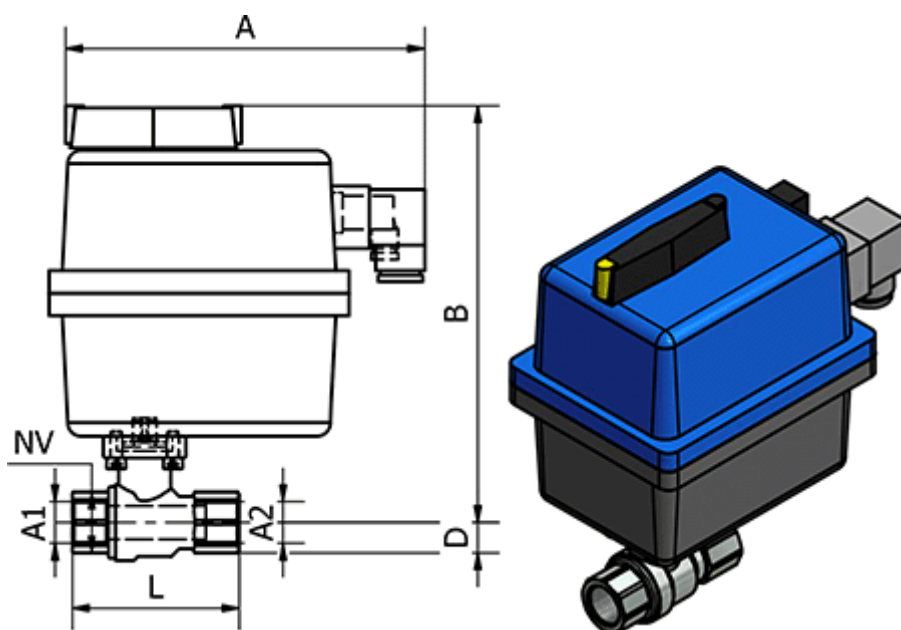

= -	D	= 25
= -	L	= 90
= -	Max. Operating Pressure	= 40 bar
= -	NV	= 41

A = 177

B = 214

Connecting A1 = G 1"

Connecting A2 = G 1"